

# DVDO AIR<sup>3C</sup>-PRO™

WirelessHD® Adapter



# Package Contents

TRANSMITTER

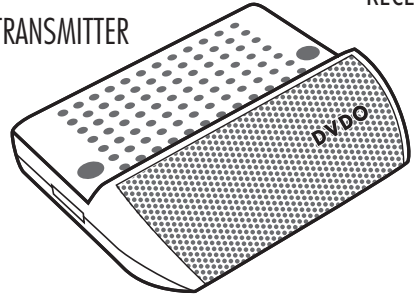

RECEIVER

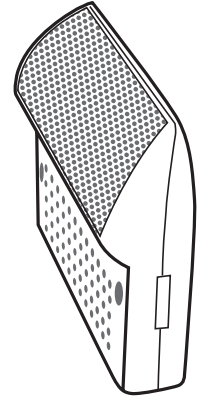

HDMI CABLES (2)

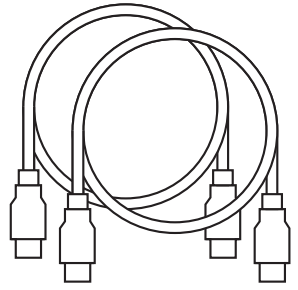

POWER SUPPLY (2)

(Actual power supply may be different than this depiction)

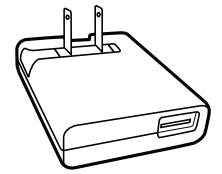

USERS GUIDE

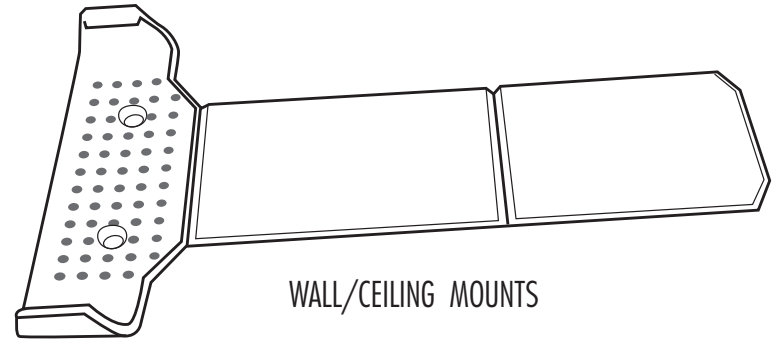
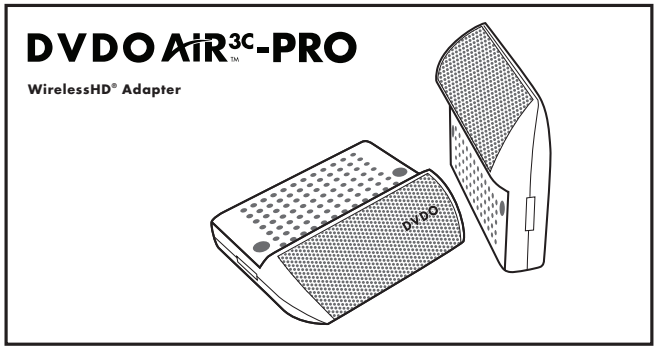

WALL/CEILING MOUNTS

## Professional Setup and Configuration Software

Download from [dvdo.com/air3CPRO](http://dvdo.com/air3CPRO)

### Configuration Utility allows professional installer to:

- Upgrade firmware
- Monitor and peak signal strength
- Set pairing mode: WiHD, Soft Pair, Hard Pair
- Set paired addresses
- Monitor link and video
- Works exclusively with Air<sup>3C</sup>-PRO

### What you need to know

- DVDO Air<sup>3C</sup>-PRO Transmitter and Receiver should be in the same room
- Best performance is within 10 Meters
- The signal bounces off walls/ceiling
- Will work with multiple transmitters and receivers
- Best performance is with receiver just visible over top of TV to provide a direct line-of sight to transmitter

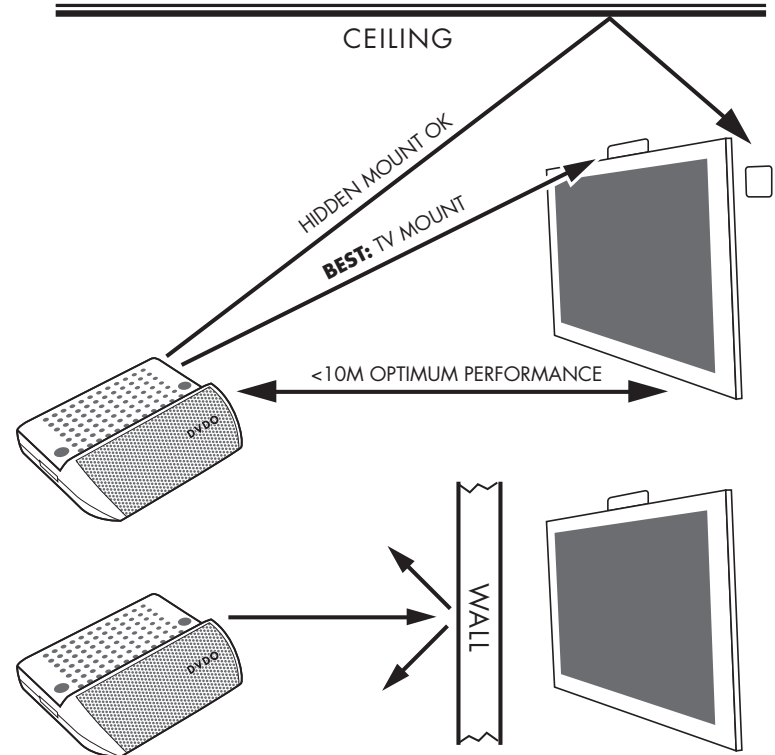

## Getting Started

1. Power everything down
2. Connect HDMI cable from Air<sup>3C</sup>-PRO receiver to TV
3. Connect HDMI cable from Air<sup>3C</sup>-PRO transmitter to Source
4. Mount the Air<sup>3C</sup>-PRO receiver on top of or behind your TV with included mounts
5. Connect USB power supply to transmitter using supplied USB cable
6. Connect Receiver to TV USB port using supplied USB cable.  
If inadequate, use supplied USB power adapter
7. Power everything back up

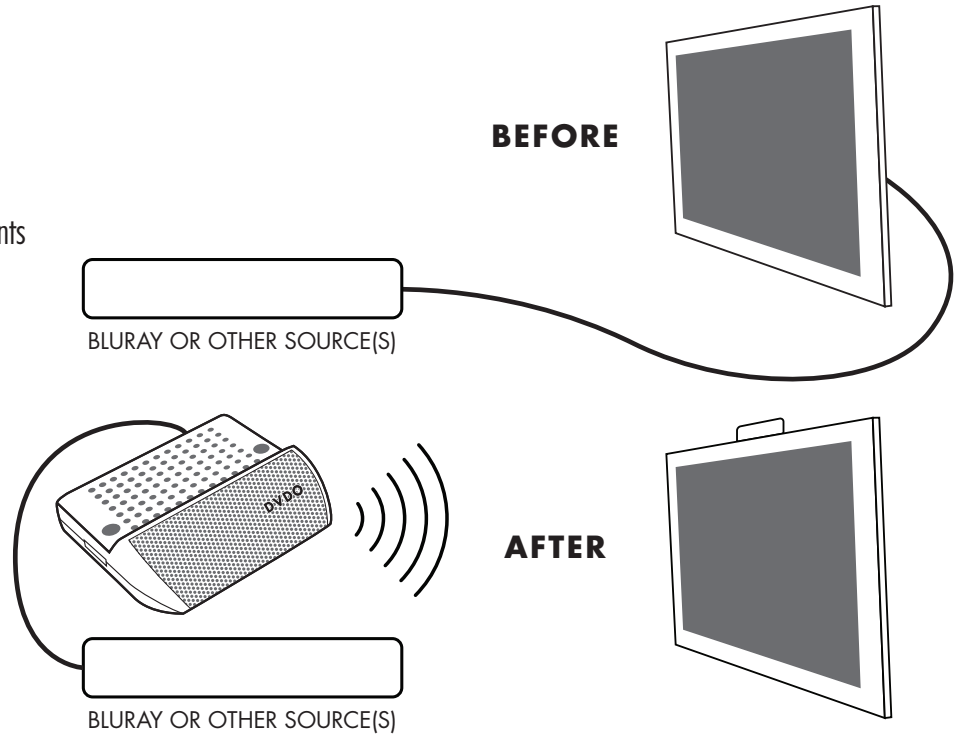

## Back Panels

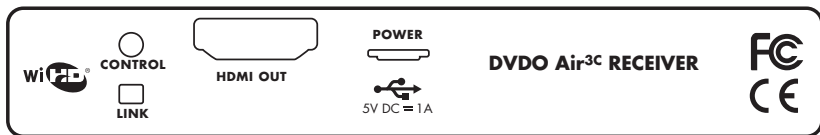

### Receiver

Link LED:

Fast blink - searching

Slow blink - connected

Solid on - receiving video

Control Button:

~2-3s press - scan for and connect to another transmitter

>5s press (until LED goes off) - reset to factory defaults and connect to first transmitter found

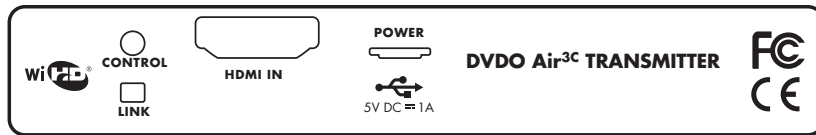

### Transmitter

Link LED:

Fast blink - searching

Slow blink - connected

Solid on - receiving video

Control Button:

~2-3s press - scan for and connect to another receiver

>5s press (until LED goes off) - reset to factory defaults and connect to first receiver found

## Receiver Mounting

Wall mount - use standard drywall screws and mount the receiver directly to drywall right through the holes in the case.

Ceiling mount - break off both tabs from bracket and using drywall screws mount bracket to ceiling. Then clip receiver into bracket with mesh facing down and toward transmitter.

Back of TV mount - If your TV is on a hinged arm, use the included Wall/TV mounting bracket and the adhesive pads to position the receiver as shown. Break off extra bracket tab for smaller TVs. Using 2 pads is recommended.

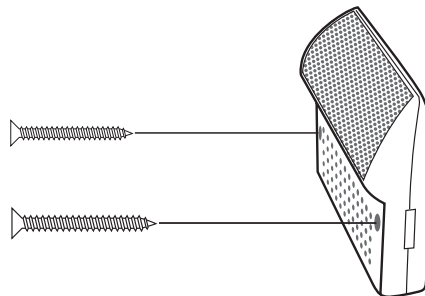

## Transmitter Mounting

Transmitter can be mounted to a wall/ceiling directly using drywall screws or placed on top of a bluray or AVR. Unit should be placed with the DVDO logo rightside up.

For best performance, transmitter and receiver mesh faces should point at each other or at a nearby surface for a bounced signal. (ceiling, wall)

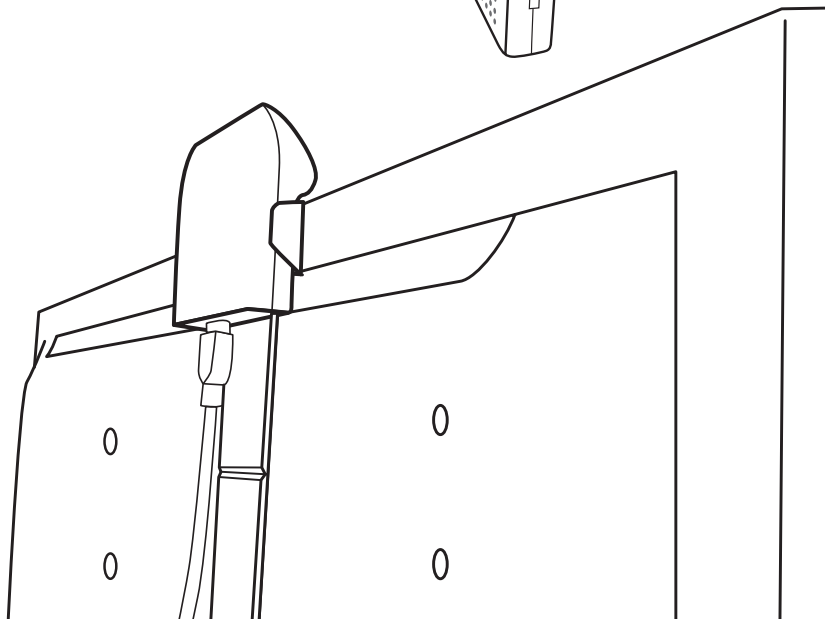

## Technical Specifications

- 60GHz band - 2 independent channels available
- Beam forming technology prevents interference between nearby units and maximizes range
- Low Latency for Gaming
- Max throughput 4Gbps
- WiHD® Certified
- HDCP Support
- Range: up to 10M

Supports up to 1080p/3D and 8ch PCM/192KHz/HD Audio

For multiple transmitter/receiver installations and troubleshooting see online FAQs at [www.DVDO.com](http://www.DVDO.com)

**HDMI**® HDMI, the HDMI logo and High-Definition Multimedia Interface are trademarks or registered trademarks of HDMI Licensing LLC.



WiHD and the WiHD logo are trademarks licensed for use by WiHD LLC.



- Follow all instructions
- Use only a dry cloth to clean
- Use caution not to block any vents in either unit
- To reduce the risk of electric shock, do not use near water or expose to rain or moisture
- Keep away from excess moisture
- Do not use near heat sources such as room heaters, hot A/V equipment
- Read all warnings
- Use only accessories approved by DVDO including mounting brackets
- Unplug both devices during lightning storms or when unused for long periods of time
- Keep away from open flames
- Protect all connected cords including power cords from being pinched, compressed, stepped on
- Do not open the case. All servicing should be done only by qualified and approved service personnel

## Customer Support

[info@dvdo.com](mailto:info@dvdo.com) | 1-888-651-1765 | [www.dvdo.com](http://www.dvdo.com)

## Legal Notices and Safety Instructions

### FCC Class B Radio Interference Statement

This equipment has been tested and found to comply with the limits for a class B digital device pursuant to Part 15 of the FCC Rules. These limits are designed to provide a reasonable protection against harmful interference in a residential installation. This equipment generates, uses and can radiate radio frequency energy, and if not installed and used in accordance with the instruction, may cause harmful interference to radio communications. However, there is no guarantee that interference will not occur in a particular installation. If this equipment does cause harmful interference to radio or television reception, which can be determined by turning the equipment off and on, the user is encouraged to try to correct the interference by one or more of the following measures:

1. Reorient or relocate the receiving antenna.
2. Increase the separation between the equipment and receiver.
3. Connect the equipment into an outlet on a circuit different from that to which the receiver is connected.
4. Consult the dealer or an experienced radio/TV technician for help.

**FCC Statement:** This device complies with Part 15 of the FCC rules. Operation is subject to the following two conditions: (1) this device may not cause harmful interference, and (2) this device must accept interference received, including interference that may cause undesired operation.

### Notice:

1. Any changes or modifications not expressly approved by the party responsible for compliance may void the user's authority to operate equipment
2. Shielded interface cables and AC power cord, if any, must be used in order to comply with the emission limits.
3. The manufacturer is not responsible for any radio or TV interference caused by unauthorized modification to this equipment. It is the responsibility of the user to correct such interference.

### FCC Radiation Exposure Statement

This equipment complies with FCC radiation exposure limits set forth for an uncontrolled environment. This equipment should be installed and operated with minimum distance of 20cm between the radiator and your body.

DVDO™, the DVDO family product logos (Quick6™, Matrix6™, DVDO Air™, DVDO Air3™, DVDO Air3C™, DVDO Air3C-PRO™, iScan™Duo and PReP™), are trademarks or registered trademarks of DVDO, Inc. in the United States or other countries.

Silicon Image®, the Silicon Image logo, Instaport®, the Instaport logos, InstaPrevue®, Simplay®, Simplay HD®, UltraGig™ and the UltraGig logo are trademarks or registered trademarks of Silicon Image, Inc. in the United States or other countries. HDMI® and the HDMI High-Definition Multimedia Interface logo are trademarks or registered trademarks of, and are used under license from, HDMI, LLC. in the United States or other countries. MHL® and the MHL logo are trademarks or registered trademarks of, and are used under license from, MHL, LLC. in the United States or other countries. WirelessHD®, the WirelessHD logo, WiHD® and the WiHD logo are trademarks, registered trademarks or service marks of SiBeam, Inc. in the United States and/or other countries.

HDMI Licensing, LLC; MHL, LLC; Simplay Labs, LLC; and SiBeam, Inc. are wholly owned subsidiaries of Silicon Image, Inc.

All other trademarks and registered trademarks are the property of their respective owners in the United States or other countries. The absence of a trademark symbol does not constitute a waiver of Silicon Image's trademarks or other intellectual property rights with regard to a product name, logo or slogan.

# DVDO

### CUSTOMER SUPPORT INFORMATION

EMAIL: [INFO@DVDO.COM](mailto:INFO@DVDO.COM)

PHONE: 1-888-651-1765

WEB SITE: [WWW.DVDO.COM](http://WWW.DVDO.COM)

**3350 SCOTT BLVD, BLDG 49  
SANTA CLARA, CA 95054**

DVDO-UG-1003